



# SCUDO

BEAUTIFUL BATHROOMS

Thermostatic Recessed Dual Control Shower Valve

## Installation Instructions & User Guide

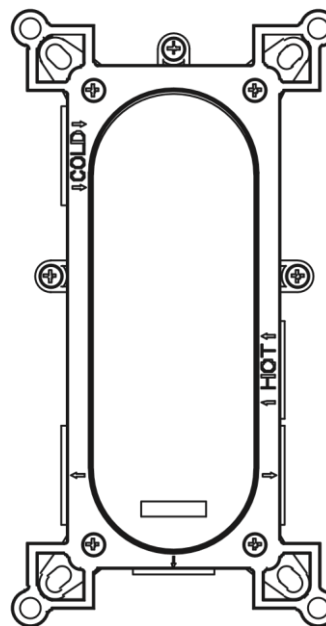
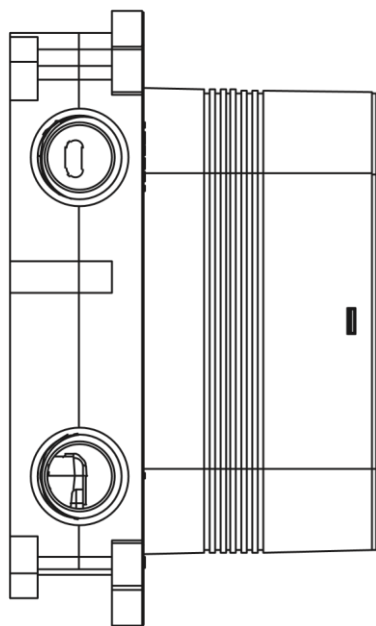
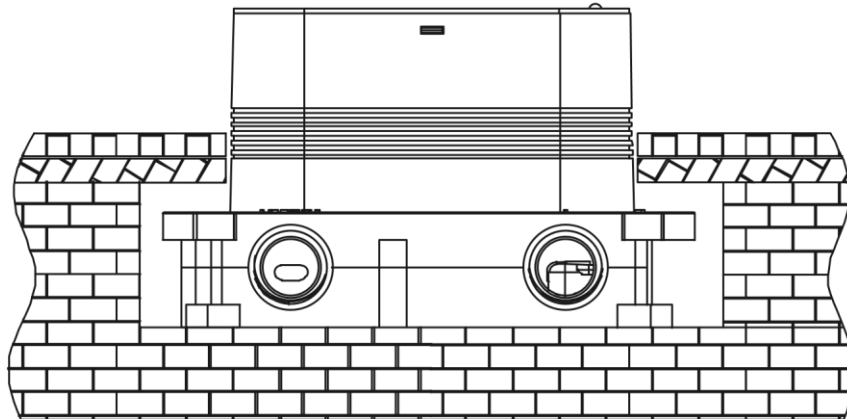

Models Covered: NU-024



**IMPORTANT:** Please keep these instructions for future reference.

## Contents:

Thank you for choosing Scudo. We have designed this product with our customers in mind. To ensure that it works as we intended, it needs to be fitted by a professional. These fitting instructions give you all of the information you need for installation. Do not hesitate to call our customer service team on 0330 124 7290 for assistance.

Important Safety Information.....	1
General Information.....	2
Prior to Installation.....	3
Installation.....	4
Shower Valve .....	5
Wall Outlet .....	6
Operating the Shower.....	7
Maintenance.....	8
Adjusting the Temperature.....	9
Troubleshooting.....	10





## Important Safety Information:

- Please thoroughly read this set of instructions and retain for future use.
- All products manufactured and supplied by Scudo are safe provided they are installed, used correctly and receive regular maintenance in accordance with these instructions.

• To safely install this product please employ the the services of an experienced plumber.

- These fittings must meet the requirements, and be installed in accordance with the Water Supply (Water Fittings) Regulations 1999 and Scottish Byelaws 2004.
- Check there are no missing or damaged parts before installation.
- Before starting any installation please consider the following:
- Before drilling into walls, check that there are no electrical wires, cables or water supply pipes. This can be checked with a electronic detector
- When using power tools do not forget to: - Wear appropriate PPE  
- Unplug equipment after use

• **Warning:** Before installing the new shower valve, it is essential that you thoroughly flush through the pipework in order to remove any remaining swarf, solder, etc. Failure to carry out this procedure could cause problems or damage to the workings of the shower valve.

- Advised to install appropriate isolation to the inlet feeds.
- Do not block the flow of water from the showerhead by placing it (smothering it) on your hand or any other part of your body or foreign object.
- Do not crush or kink the shower hose, this could damage the hose causing leaks.

• **Warning:** Do not operate this product if you suspect it is frozen. Do not site mixing valve where it might be subjected to freezing conditions.

- These shower valves **must** not be modified in any way as this will invalidate the guarantee.

## General Information:



This product has been tested to the Water Regulations Advisory Scheme (WRAS) and satisfies the requirements of the Water Supply (Water Fittings) Regulations 1999 and current bylaws.

BS7600 recommends the temperature of stored water should never exceed 65°C. A stored water temperature of 60°C is considered sufficient to meet all normal requirements and will minimise the build up of lime scale in hard water areas.

If the shower valve is installed at low pressure (tank fed), then the minimum distance from the highest installed position of the showerhead to the underside of the cold tank should be at least 1 metre to ensure adequate performance. It is recommended low pressure systems are pumped to ensure minimum 0.5 bar of pressure.

**Note:** Nominally equal (balanced) inlet supply pressures are recommended for optimum performance.

This shower valve should be installed in compliance with the Water Supply (Water Fittings) Regulations 1999 and the Scottish Bylaws 2004.

Recommended Usage			
Domestic	✓	Heavy Commercial	✗
Light Commercial	✓	Health Care	✗



## Pack Contents: NU-022 / NU-023 / NU-024

1. Concealed Dual Outlet x1
2. Shower Wall Arm x1
3. Handle Shrouds x2
4. Concealed Plate 1x
5. Valve Body Fixings x4
6. Handle x2
7. Insert x1
8. Temperature Control x1
9. Wall Bracket & fixings x1
10. Slider Bracket x1
11. Wall Outlet/Riser Support x1
12. Riser Rail x1
13. Handset x1
14. Drench Head x1
15. 1/2 inch Washer x3
16. Ball Fixings Washer x1
17. Hose x1



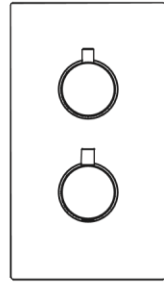
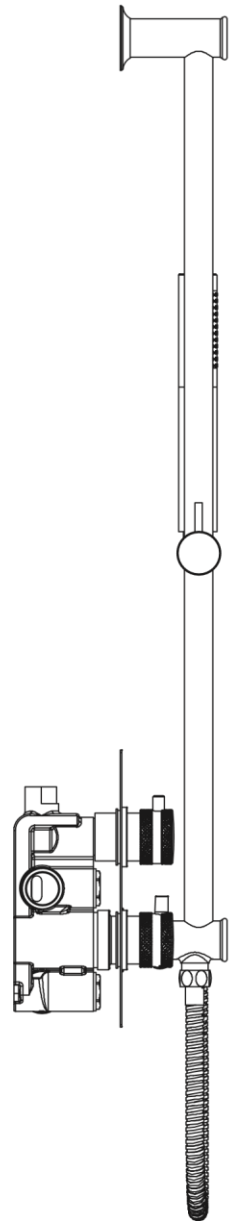
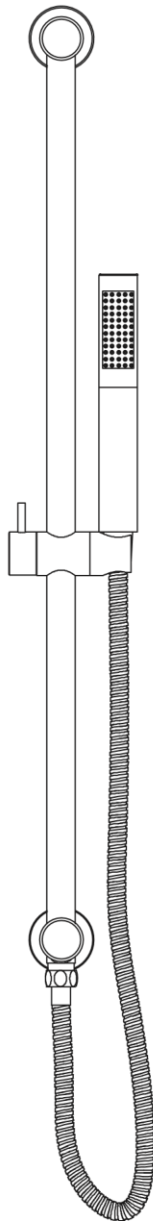
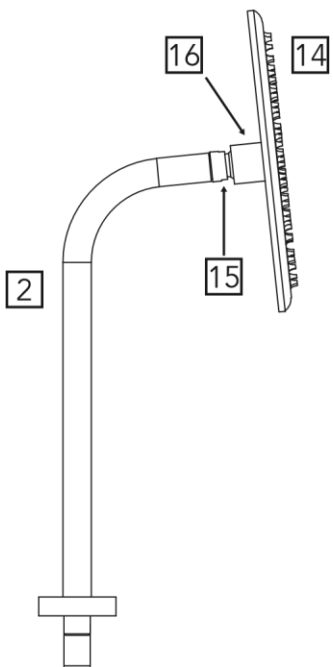

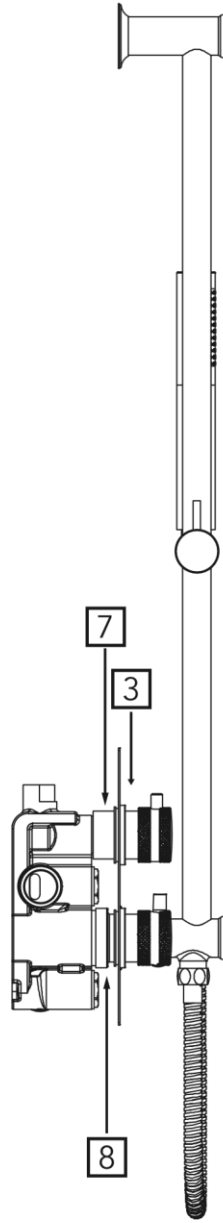
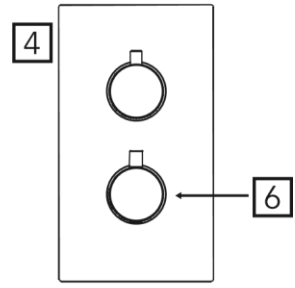
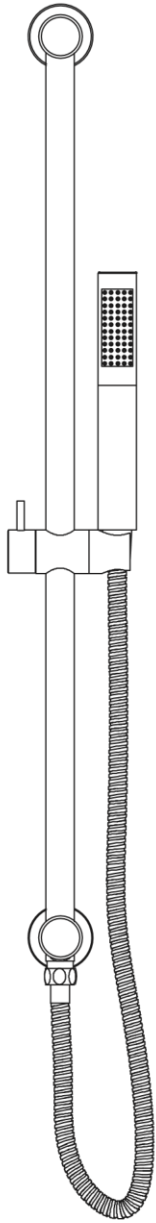
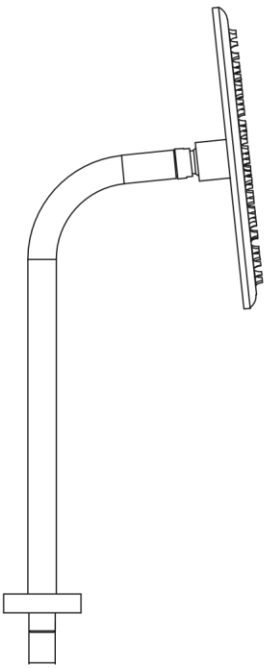

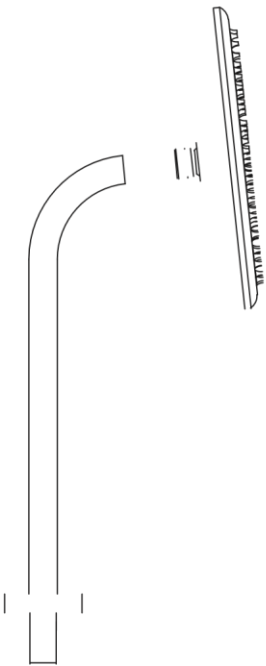
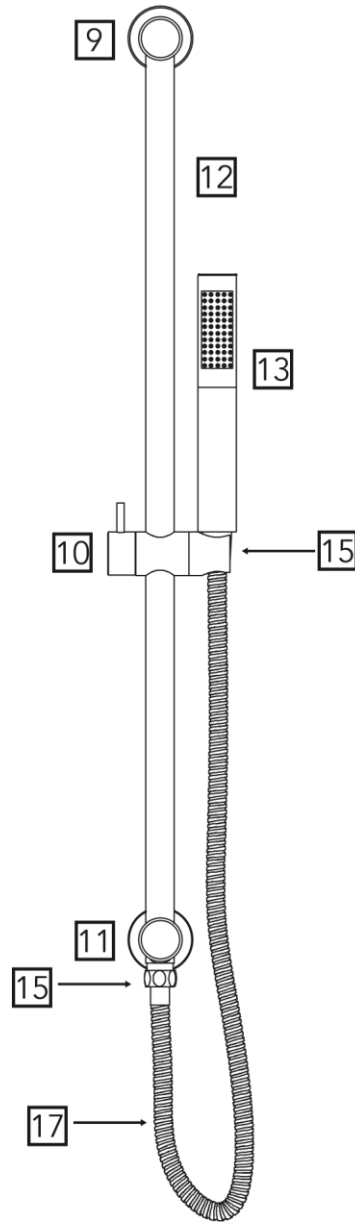
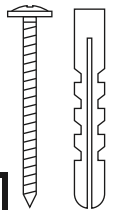
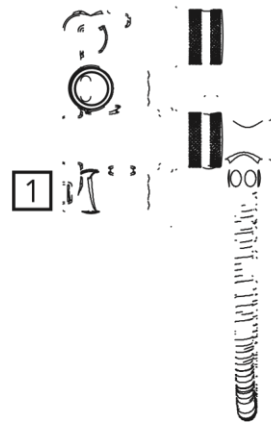
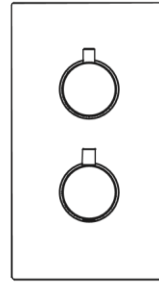

## Pack Contents: NU-028 / NU-029 / NU-030

1. Concealed Dual Outlet x1
2. Shower Wall Arm x1
3. Handle Shrouds x2
4. Concealed Plate 1x
5. Valve Body Fixings x4
6. Handle x2
7. Insert x1
8. Temperature Control x1
9. Wall Outlet/Handset mount x1
10. Handset x1
11. Drench Head
12. 1/2 inch Washer x3
13. Ball Fixings Washer x1
14. 1/2" Hose x1



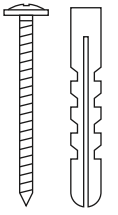
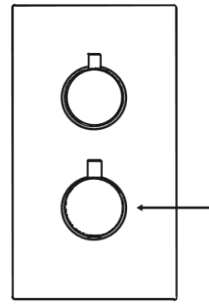
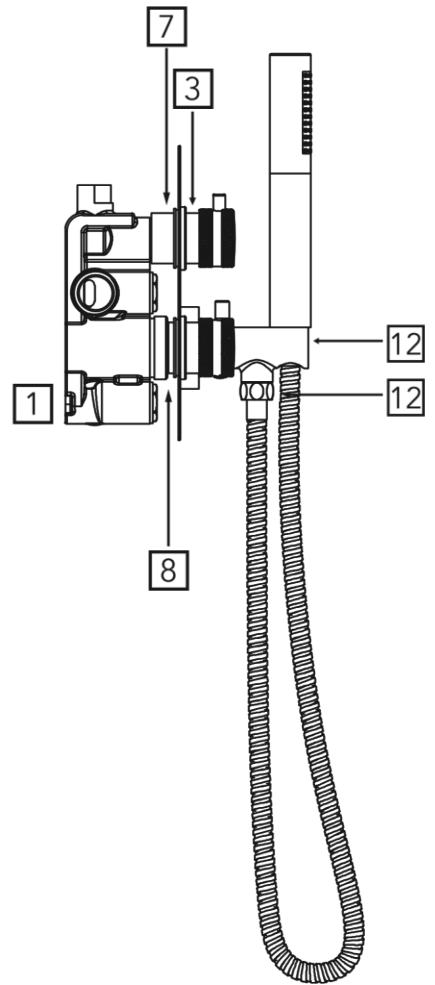
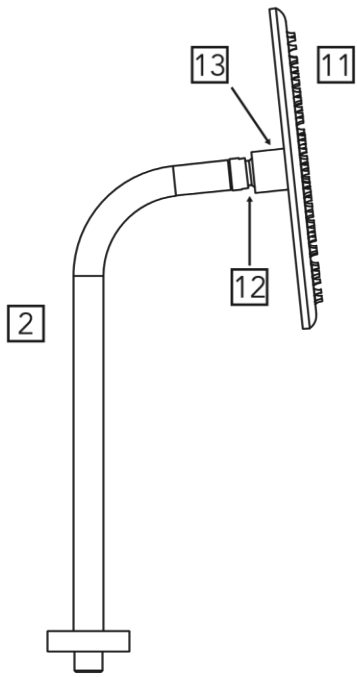



# Installation:

## Shower Valve

This shower valve is designed for installations where a recessed valve is already installed in the wall cavity and is to be replaced, or for new installations.

### Before Installation

Flush through the pipework to ensure removal of any debris. Turn off the mains water supply and close any isolating valves.

#### 1. Attach shower valve to wall

Place the shower valve in the required position and mark the centres of the fixing holes onto the wall.

**Warning:** Please check for any hidden pipes and cables before drilling holes in the wall.

Drill suitable holes and insert the wall plugs. Securely attach the shower valve to the wall using the screws supplied.

#### 2. Connect water supply pipes

Insert 15mm hot and cold water supply pipes into the inlet connections and tighten nuts, ensuring the olives are fitted.

#### 3. Plumb in outlets

Insert 15mm pipework into the top outlet and plumb into the users chosen product. Ensure the olives are fitted when tightening the nuts.

**Important:** Water supplies to the mixer must be with hot on the left and cold on the right when viewed from the front.

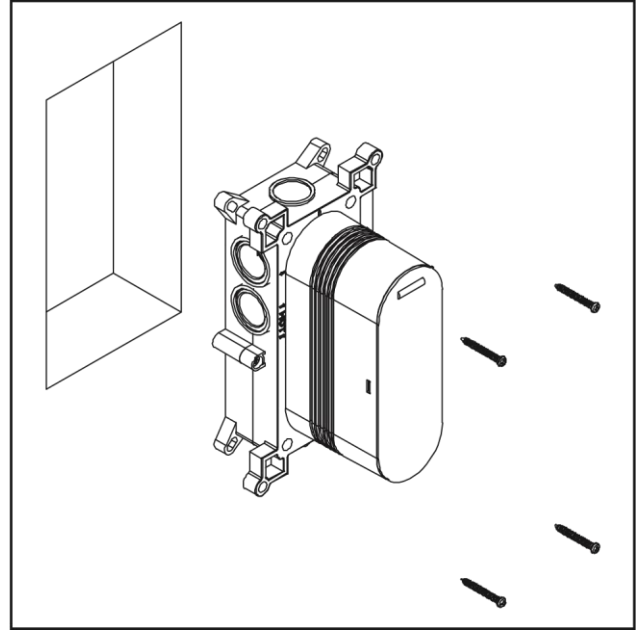

## Installation:

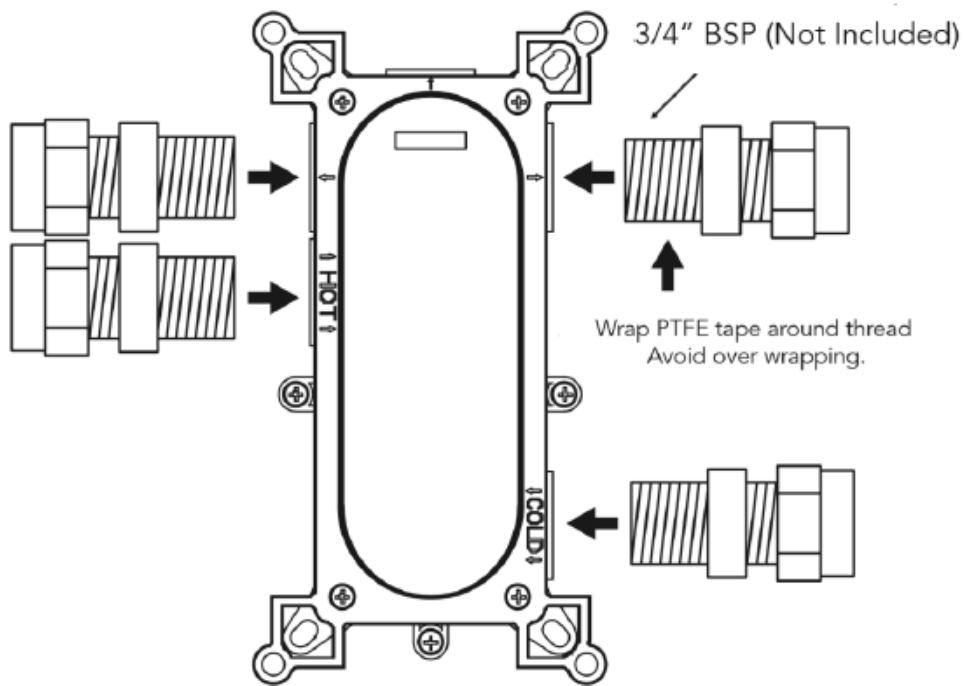

Shower Valve

### **4. Finish wall surface**

Plasterboard and tile the cavity wall. After cut down plastic case to be flush against the wall. Fit the shrouds after this process.



## Installation:

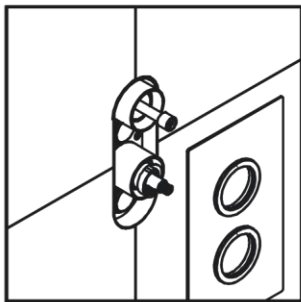
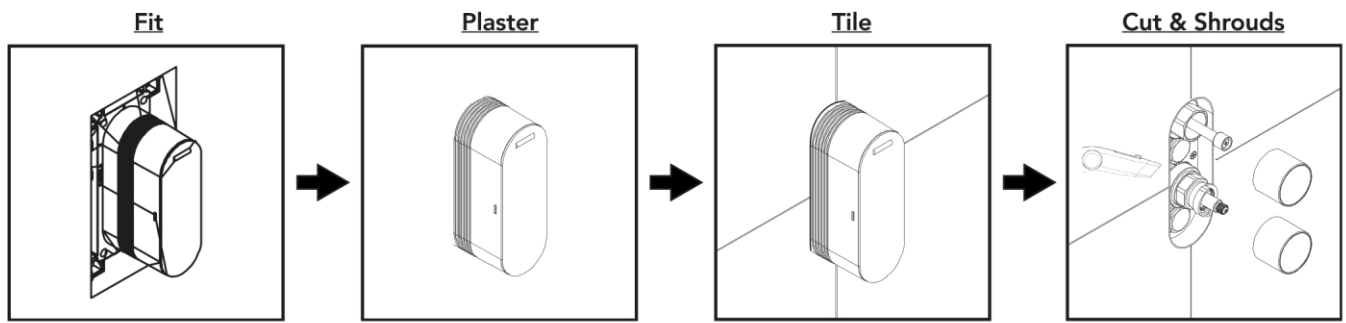

### **5. Fit concealing plate and handles**

Run a bead of waterproof silicon sealant around the inner edge of the concealing plate.

Slide the concealing plate onto the shower valve control handles and apply firm pressure to ensure to silicon sealant spreads.

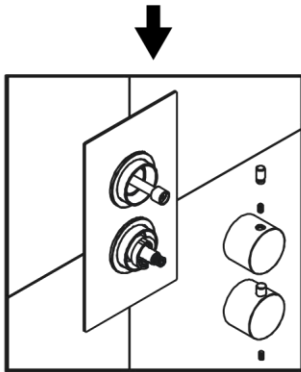

### **6. Fit handles**

Push the spline adaptors onto the valve spindles.

Push the handles onto the spline adaptors and secure by tightening the grub screw and push-fit the cap into position.

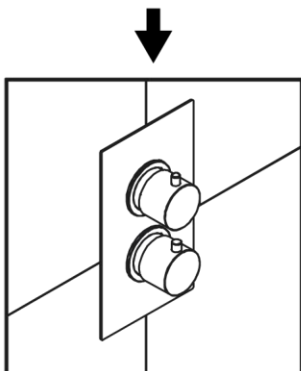

## Installation:

### Wall Arm and Drench Head

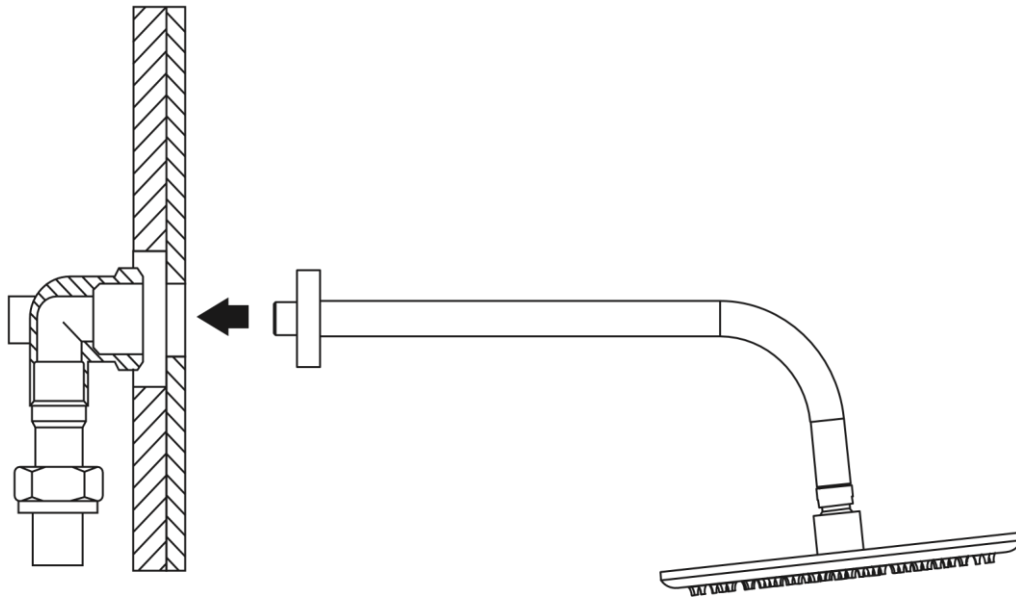

Wrap PTFE Tape around the thread on the wall arm and screw into the back plate elbow. Screw drench head onto the wall arm.

## Operating the Shower:

### **1. Two outlet diverter**

This outlet allows the user to divert the flow of water from one product to another. Turn the handle one way or the other to turn the flow of water on to your chosen product.

To turn the flow of water off turn the handle back to the centre.

### **2. Temperature control**

Adjustable temperature control. Turn the handle clockwise for a cooler temperature.

Turn the handle anti-clockwise for a hotter temperature.

OFF



# Installation:

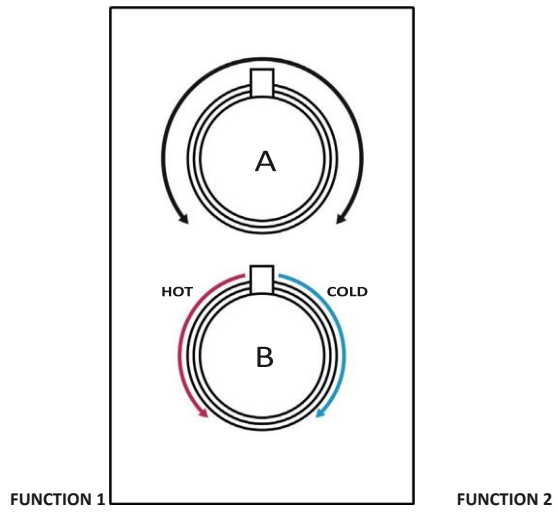

## Maintenance

### **General Cleaning**

Your fitting has a high quality finish and should be treated with care to preserve the visible surfaces. All surfaces will wear if not cleaned correctly, the only safe way to clean your product is to wipe with a soft damp cloth.

Stains can be removed using washing up liquid. All bath cleaning powders and liquids will damage the surface of your fitting, even the non-scratch cleaners.

### **Cartridge Maintenance**

We advise that the shower valve is regularly serviced in hard water areas to maintain the flow of water.

Isolate both hot and cold water supplies to the shower valve by either:

- Turning the water supply off at the mains stopcock or
- Turning off the isolation valves to the shower valve.

### **Cleaning the Shower Filter:**

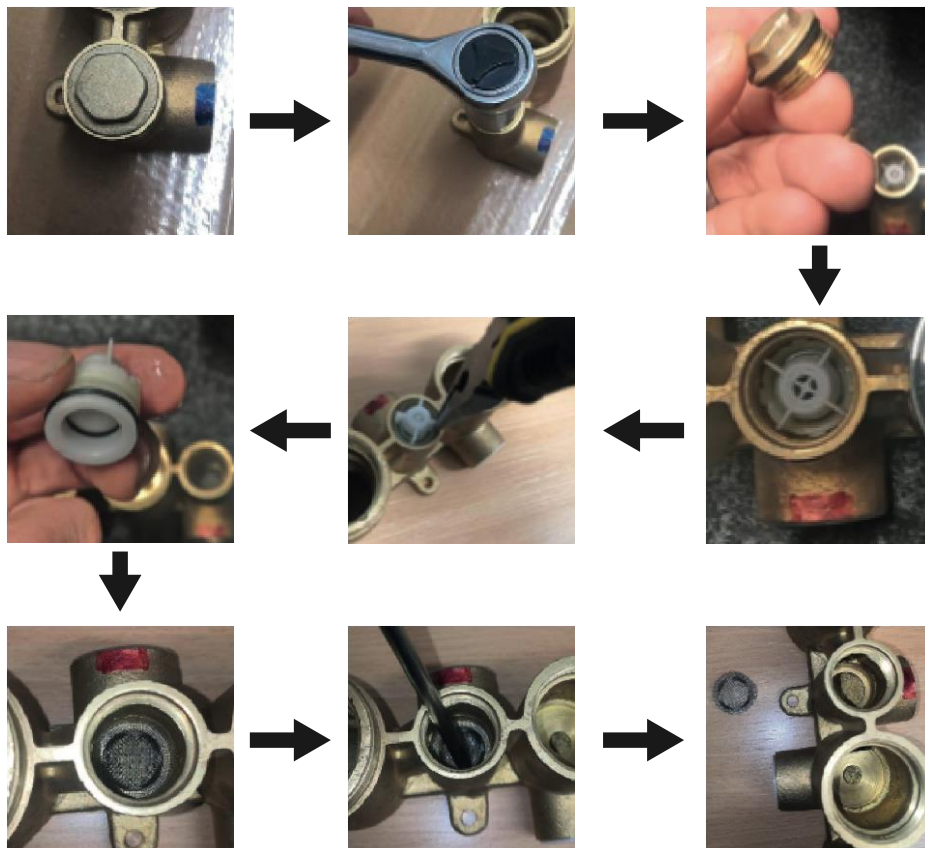

## Maintenance



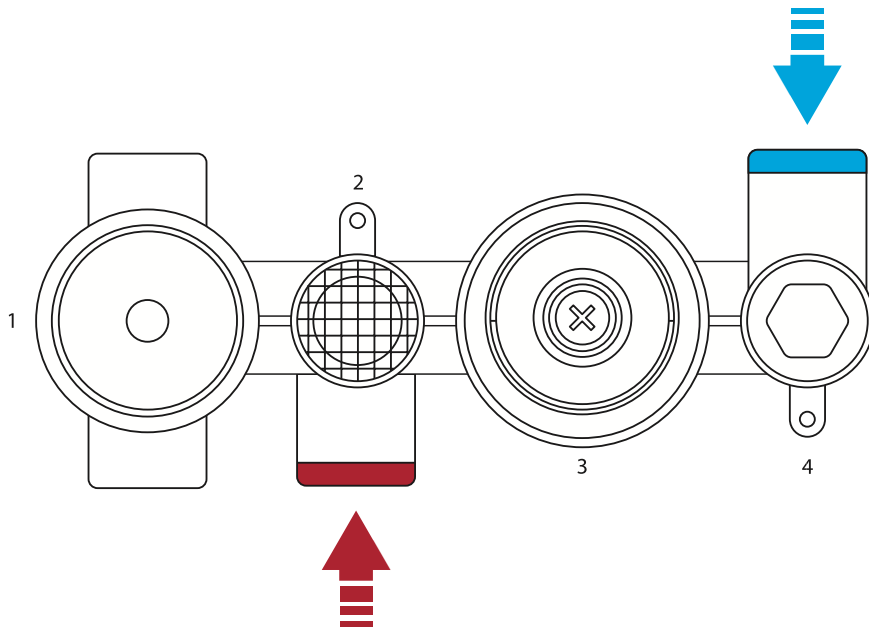

- a. Remove the cold water outlet hexagonal nut (4) using a socket wrench.
- b. Remove cartridge.
- c. Clean mesh with warm soapy water.
- d. Repeat the same for warm water outlet (2)

## Adjusting the Temperature

The shower valve has been factory set to 42°C with equal (balanced) hot and cold water supply pressures, with the hot water supply at 65°C.

If your operating conditions are different from those above, the outlet water temperature may differ from the factory setting.

If required the shower valve can be re-calibrated to suit your own temperature requirements. Set the temperature control to the maximum setting and check the temperature of the water with a thermometer. If the temperature is not correct, re-calibrate the shower valve:

1. Remove the temperature handle but do not remove the plastic temperature stop.
2. Turn the spline clockwise to decrease the temperature and anticlockwise to increase the temperature. Check the temperature and adjust until you achieve the required temperature.
3. Replace the temperature handle ensuring it is fitted back into the maximum position.

## Troubleshooting

Symptom	Cause	Remedy
	Check showerhead, hose and filters for any blockage.	Clean as necessary, refer to maintenance page.



No flow or low flow rate and / or varying temperatures.	Partially closed stop or service valve in water supply pipework to the shower valve.	Open stop or service valve.
	Instantaneous water heater cycles on and off as the flow rate or pressure is too low.	Increase water flow rate or pressure through system, Contact the boiler manufacturer.
	Head of water is below the minimum distance required.	Raise the cistern or fit a negative head shower booster pump.
	Inlet filter is partially blocked.	Clean or replace, flush through pipework before refitting.
	hot or cold water being drawn off elsewhere causing pressure changes or instantaneous boiler temperature changes.	Refer to Boiler troubleshoot
	Airlock or partial blockage of the pipework.	Flush through pipework to ensure removal of debris and any airlocks.
	No hot or cold water reaching the shower valve.	Check hot and cold feeds (the valve will shut down if either the hot or cold supply fails).
Only hot or cold water from the shower valve outlet.	Partially closed stop or service valve in water supply pipework to the shower valve.	Open stop or service valve.
	Inlet filter is partially blocked.	Clean or replace, flush through pipework before refitting.
	Inlet water supplies are reversed (hot to cold supply).	Check the connections are correct way round. Hot on the left and cold on the right when viewed from. Rework pipework as necessary
Water leaking from showerhead.	This is normal for a short time after turning it off.	Adjust angle of showerhead in holder as necessary to vary drawing time.
	Shower cartridge failing to close fully, possibly due to water borne debris.	Remove shower cartridge and check. refer to Maintenance section before dismantling shower valve.
Maximum water temperature too hot or cold	Maximum water temperature set incorrectly.	Reset maximum water temperature. Refer to 'Maximum Temperature setting' in Maintenance section and 'Adjusting the Temperature'
Outlet water temperature too hot / cold	Inlet filter is partially blocked	Check inlet filters for any blockages and as necessary.



	Installation conditions outside operating parameters.	Refer to Specification. Service shower valve as recommended. Refer to 'Maintenance' section Refer to 'Adjusting the Temperature' section
--	---	--

## Troubleshooting

Symptom	Cause	Remedy
Water temperature too cold - Maximum water temperature incorrectly set.	Hot water temperature is less than 10°C above the required blend temperature.	Adjust hot water temperature or wait for water to reheat if stored system is used.
	Instantaneous water heater not igniting because water flow rate is too low.	Increase water flow rate through the system. Check inlet filters and clean or replace. Refer to Maintenance section. Contact the boiler manufacturer.



## Notes:

Please use this space to add any notes you or your installer may have regarding the plumbing system or installation of this product.



## Notes:

Please use this space to add any notes you or your installer may have regarding the plumbing system or installation of this product.

