

8mm Wetromm Flipper Hinge Panel

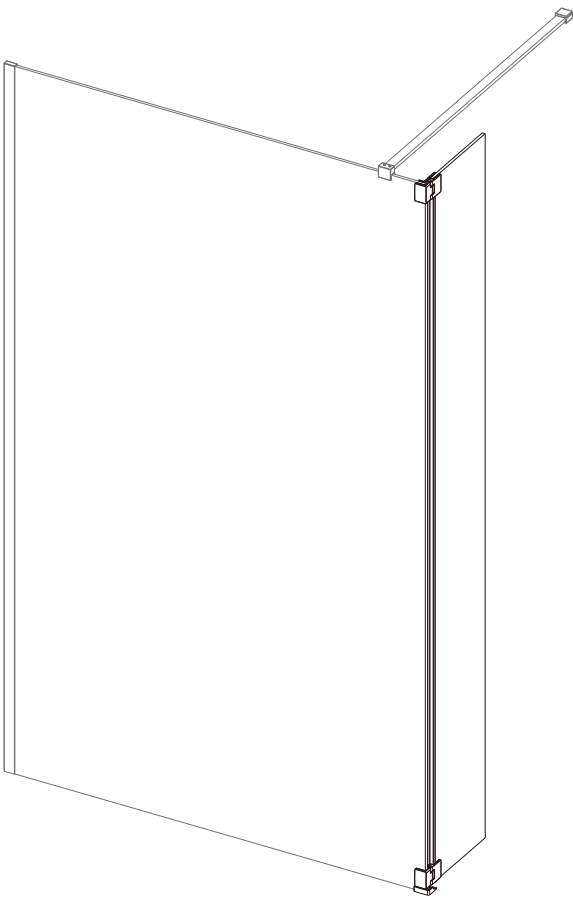

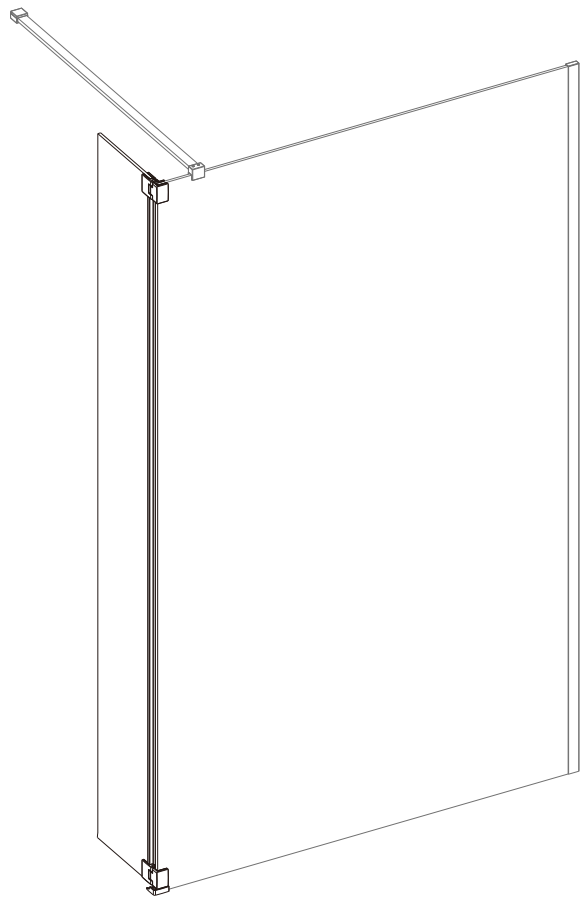





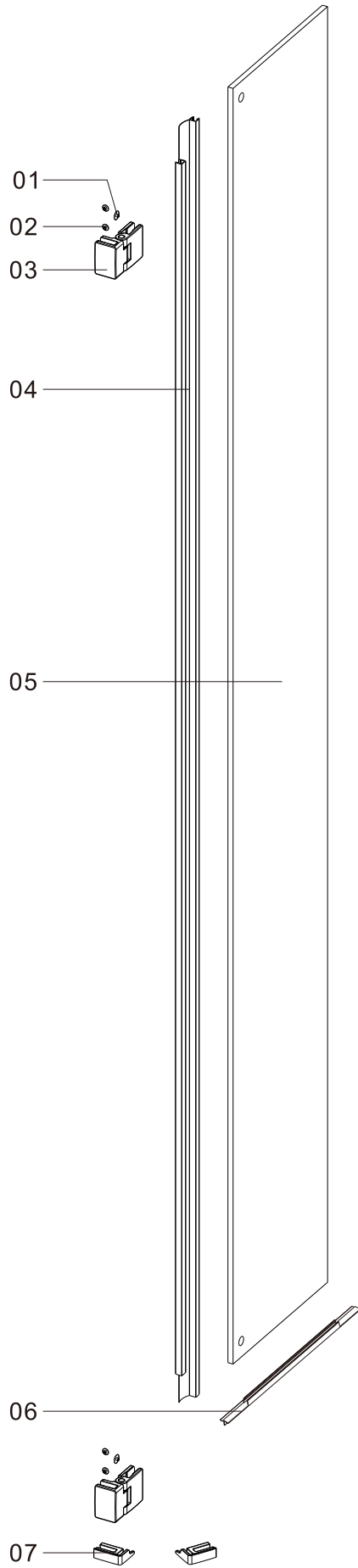







L



R

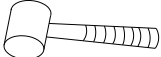
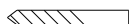
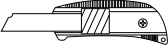

Item No.:	Part	Quantity	Description
01		x4	Hinge Cover Caps A
02		x2	Hinge Cover Caps B
03		x2	Hinges
04		x1	Seal
05		x1	Flipper Panel
06		x1	Bottom Seal
07		x2	Bottom Guide Block

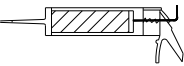
Electric drill		tape measure	
drill(ϕ 3.2mm)		rubber hammer	
drill(ϕ 6mm)		knife	
cross tip screw driver		pencil	
spirit level		silicone sealant	

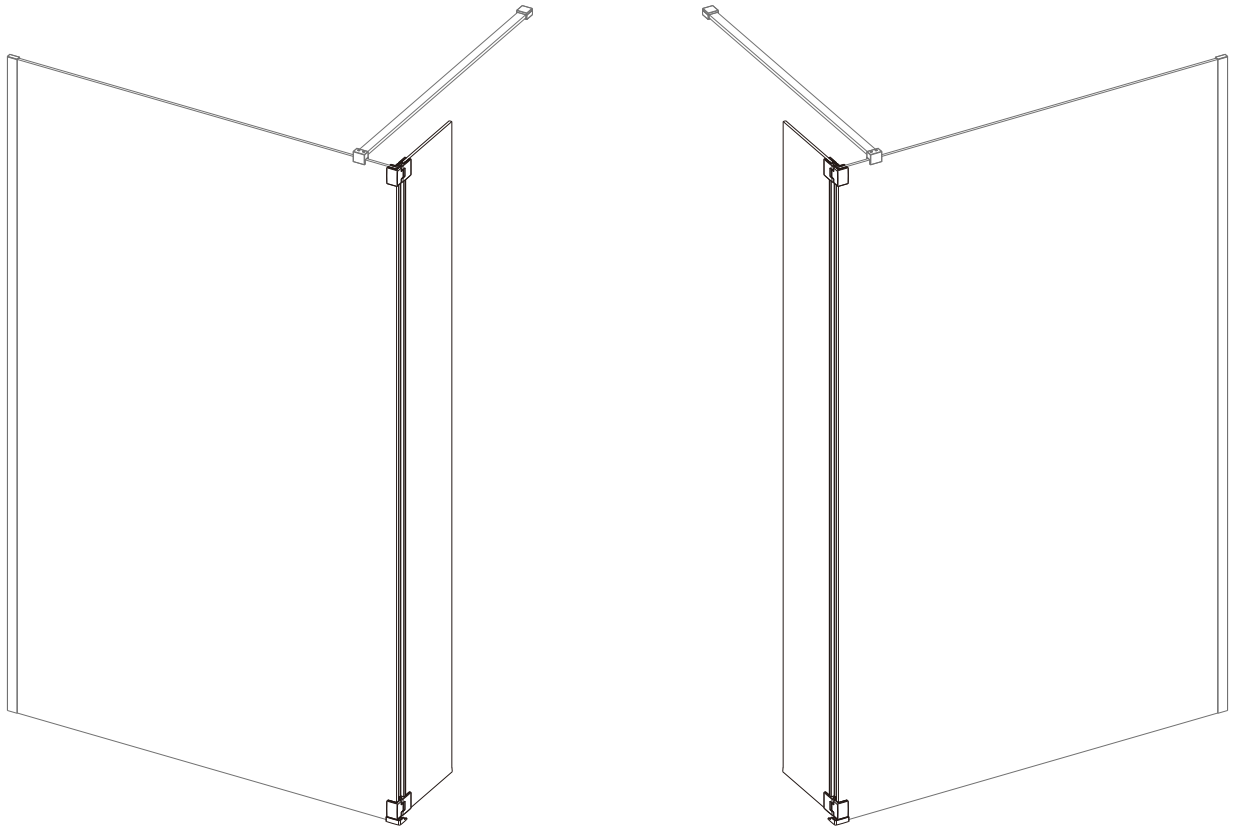

Type	A	B
FLUTEDFLIPPER	300	255

