

SCUDO



FITTED FURNITURE TECHNICAL GUIDE

FITTED FURNITURE TECHNICAL GUIDE



Scan to View
Fitted Furniture Brochure



USEFUL INFORMATION

PROFESSIONAL INSTALLATION RECOMMENDED

Our fitted furniture is designed with simplicity and elegance in mind. This brief guide will help you navigate the steps to create your dream bathroom cabinetry. The foundation of every fitted unit is the **carcass** the pre-assembled core structure that provides strength and stability.

Complementing the carcass are the **fascias**, the front panels that define the furniture's external appearance, and **end panels**, which cover the sides for a seamless, refined look. Finally, **plinths** conceal the floor and complete the overall aesthetic, ensuring a flawless finish from every angle.

Designing Your Fitted Furniture

Choose your unit - Explore the vanity options on the next page to select your preferred carcass and fascia combination.

Select a finish - Each collection offers a curated palette of colours, thoughtfully chosen to complement the fascia design and elevate the overall look.

Add a worktop & basin - Compatible worktops and basins can be found on page 50, including a refined selection of semi-recessed, countertop, and basin-and-shelf options.

Finish with hardware - All our doors are supplied undrilled, giving you the freedom to choose the perfect hardware for doors and drawers, allowing a bespoke touch that reflects your style.

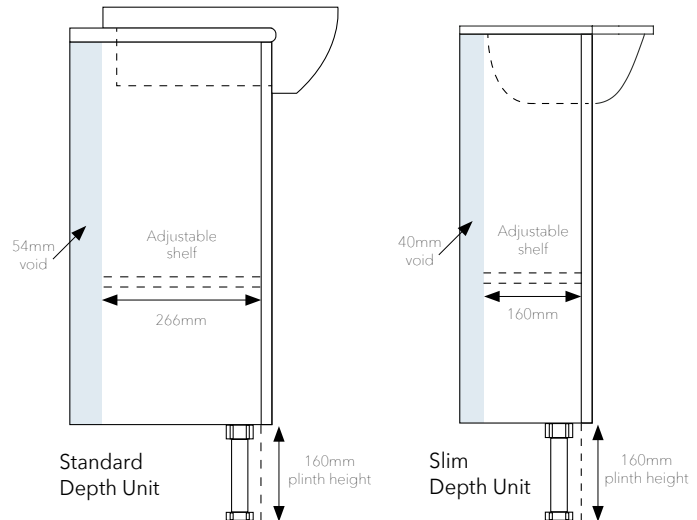

FITTED FURNITURE PARTS EXPLAINED

From end panels to plinths, there are lots of parts that make up fitted furniture units and understanding what each component is needed for can be confusing. To make things clearer, we've created the diagram below for a quick reference to all the components that make up fitted furniture.

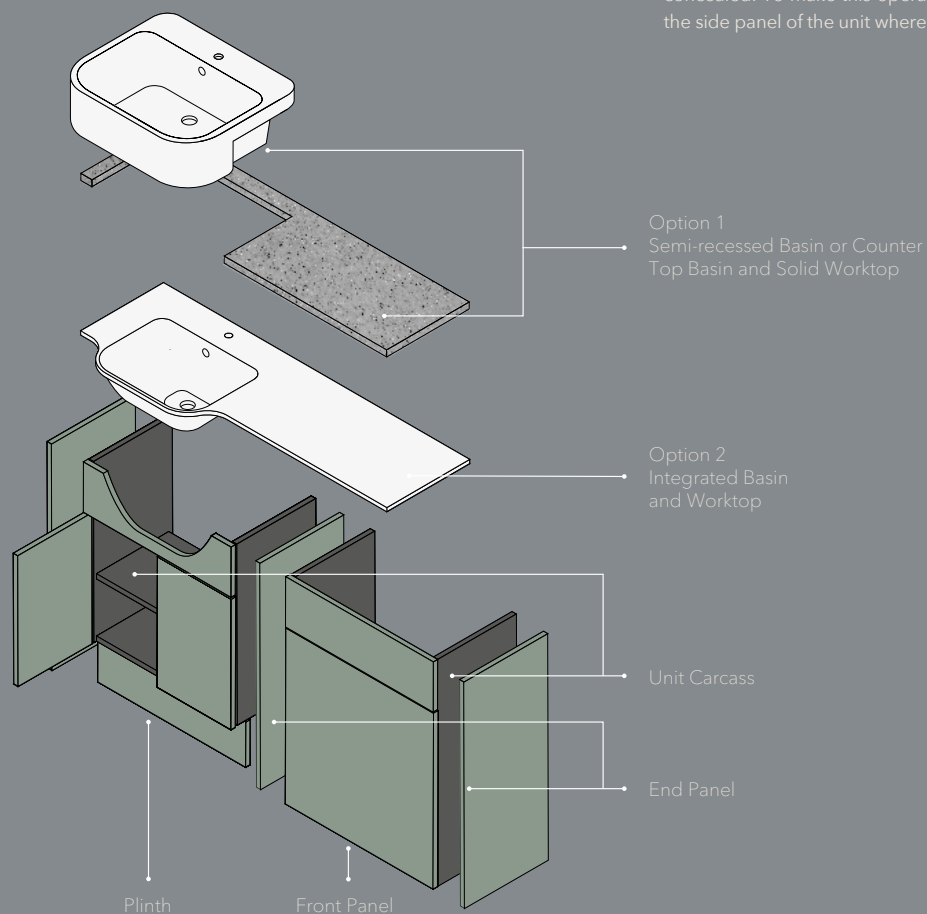

CONCEALING PIPEWORK

Pipework is essential for a functioning bathroom, however it can be unsightly unless it's concealed. When you choose our fitted furniture, you can hide any pipes behind units, whether they run along skirting boards or up walls.

The furniture is designed with a plinth height of 160mm, so even soil pipes can run under the units. In addition, units feature a void at the back that allows pipes to run along the walls while keeping them concealed. To make this operate effectively, your fitter will notch out the side panel of the unit where the pipe travels.

FITTED FURNITURE DIMENSIONS



Scan to View
Fitted Furniture Brochure





500 BASIN UNIT STANDARD DEPTH

Serene

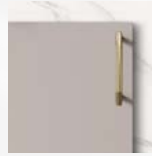

Maison



Willow

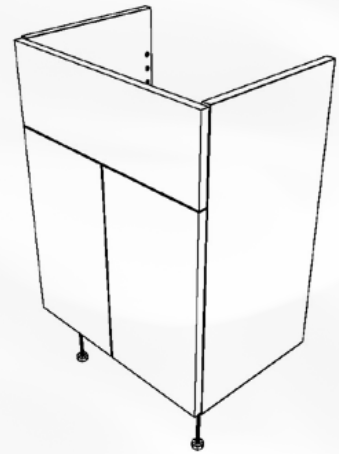
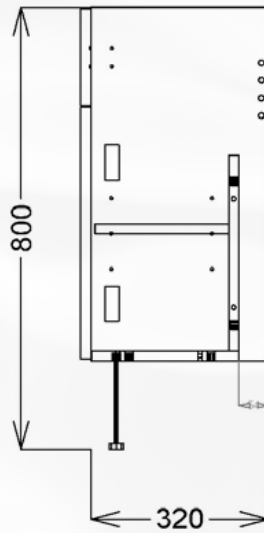
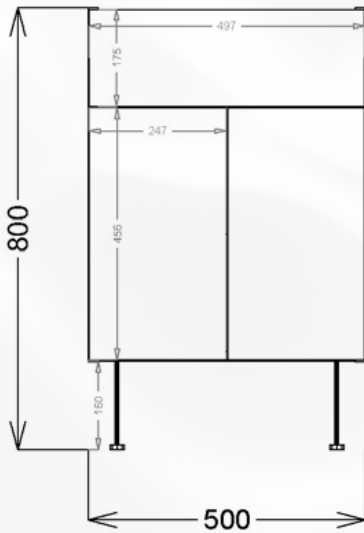
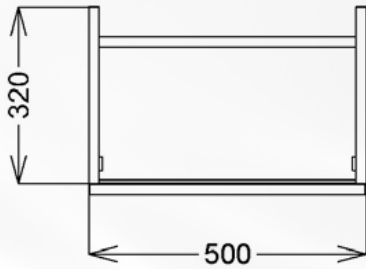

500 BASIN UNIT SLIM DEPTH

Serene



Maison



Willow

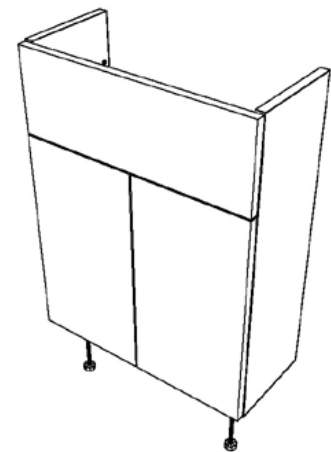
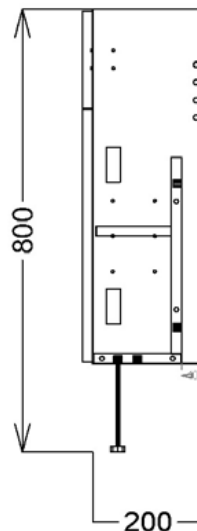
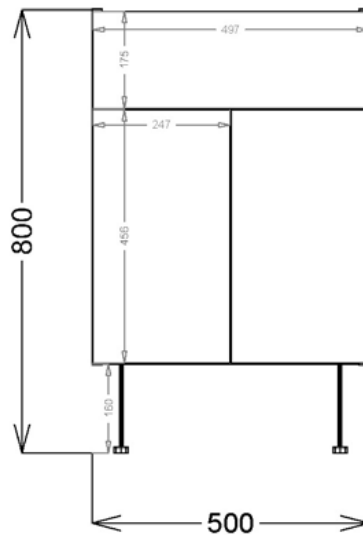
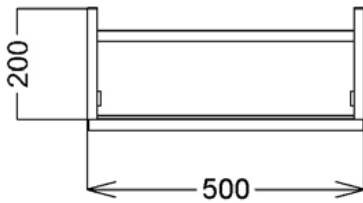

600 BASIN UNIT STANDARD DEPTH

Serene

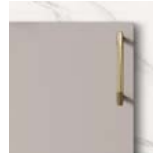

Maison



Willow

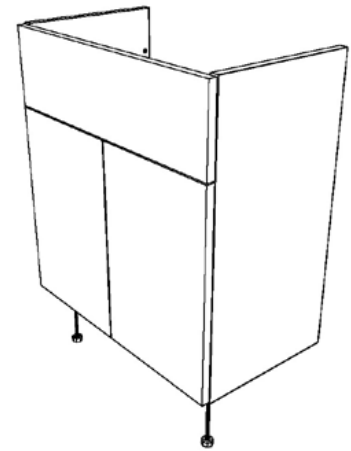
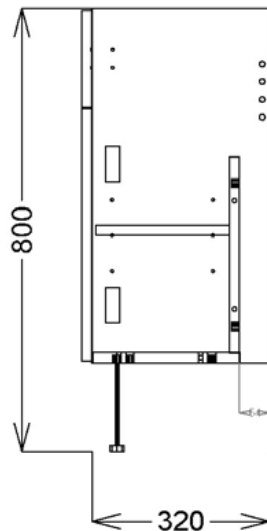
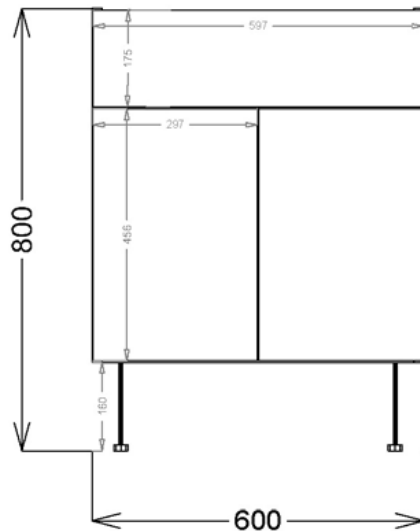
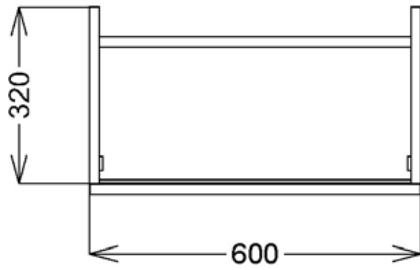

600 BASIN UNIT SLIM DEPTH

Serene

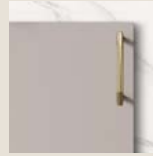

Maison



Willow

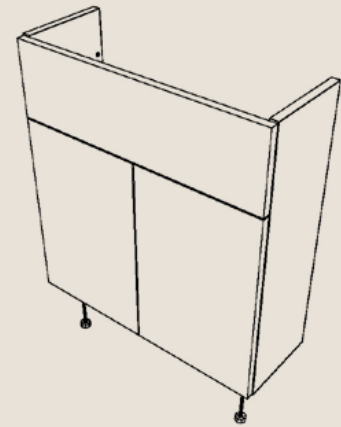
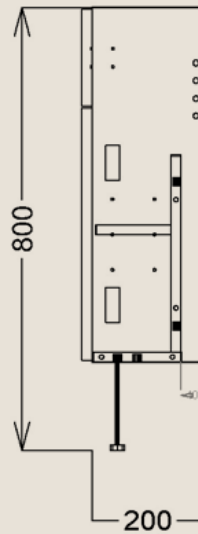
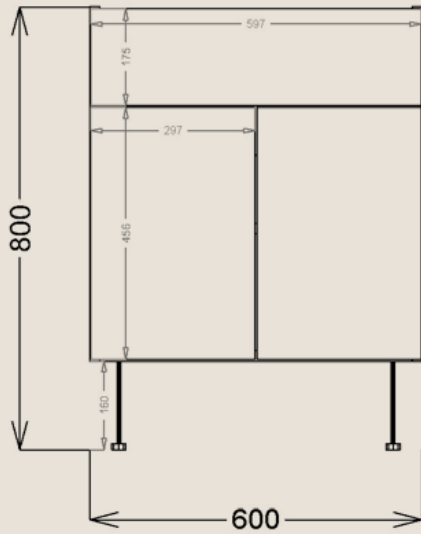
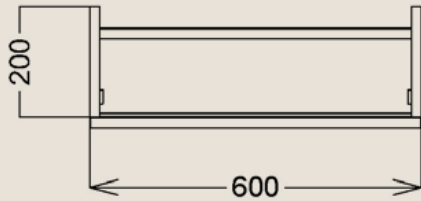

Furniture Dimension

500 WC UNIT STANDARD DEPTH

Serene

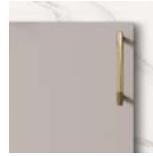

Maison



Willow

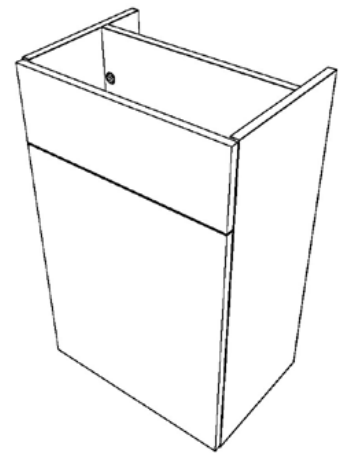
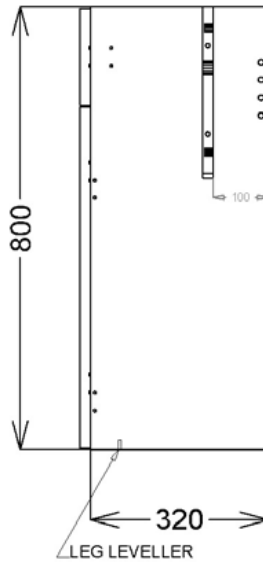
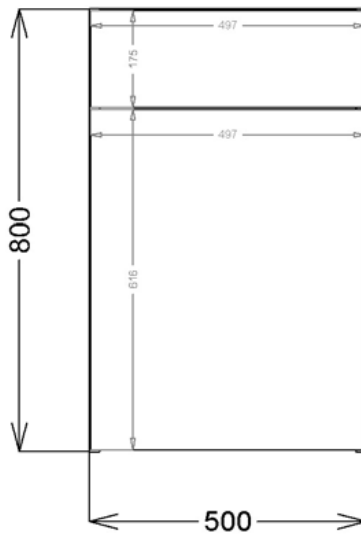
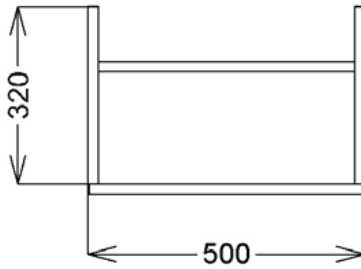

500 WC UNIT SLIM DEPTH

Serene

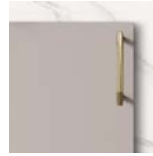

Maison



Willow

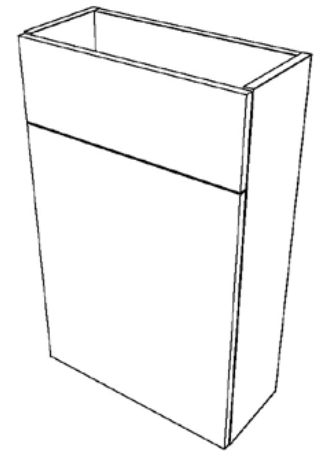
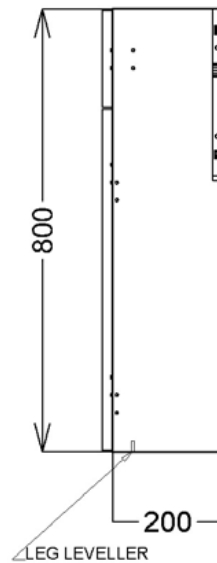
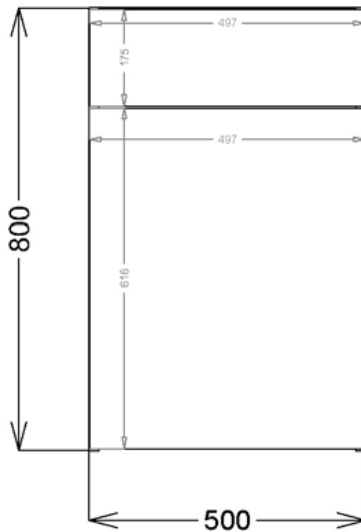
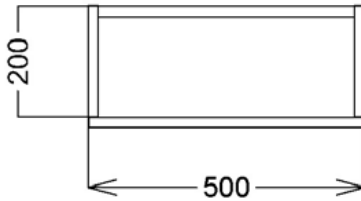

600 WC UNIT STANDARD DEPTH

Serene

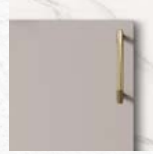

Maison



Willow

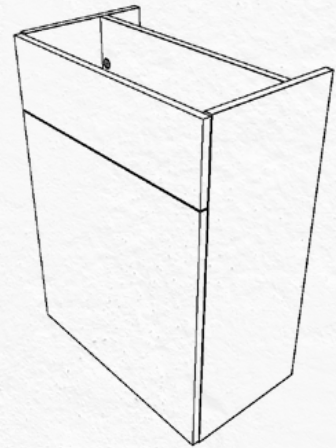
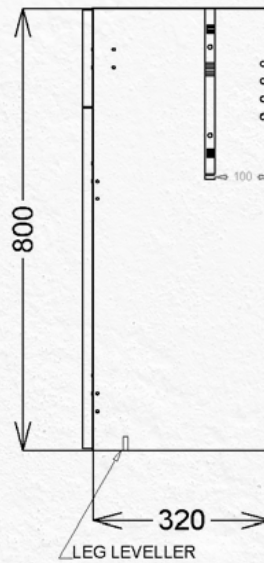
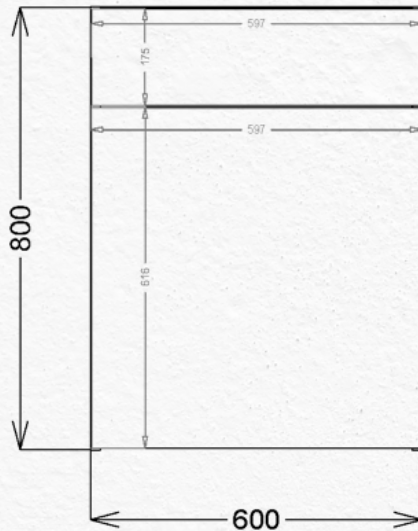
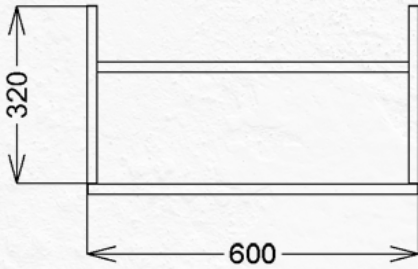

600 WC UNIT SLIM DEPTH

Serene



Maison



Willow

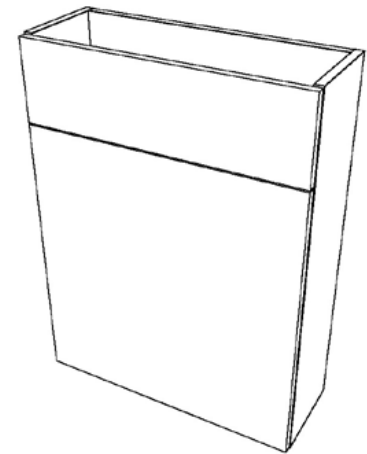
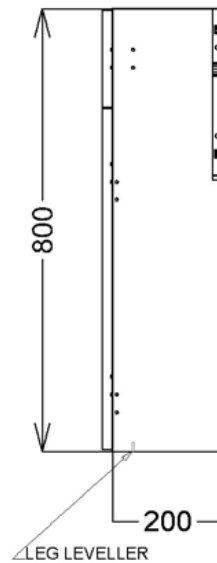
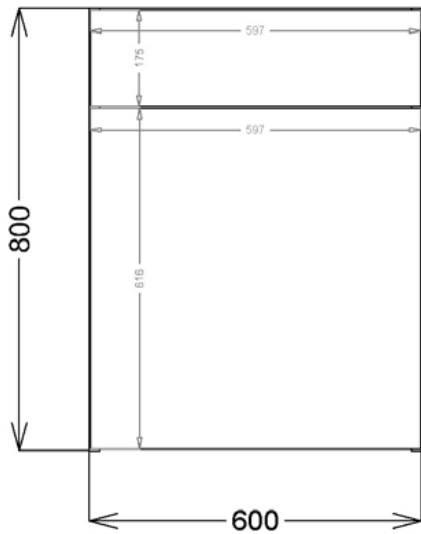
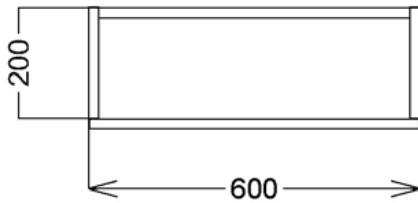

300 1 DOOR UNIT STANDARD DEPTH

Serene

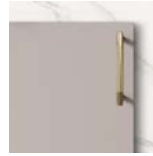

Maison



Willow

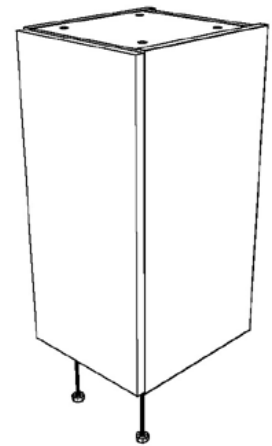
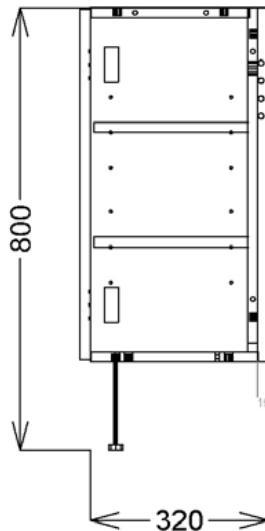
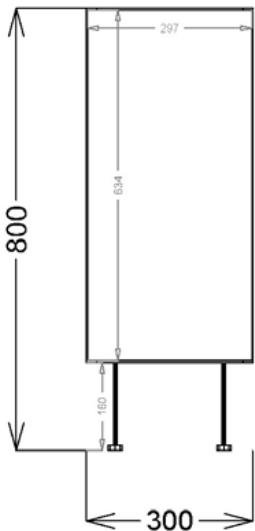
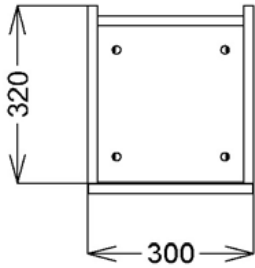

300 1 DOOR UNIT SLIM DEPTH

Serene

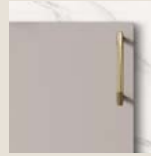

Maison



Willow

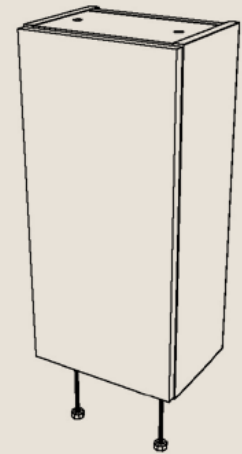
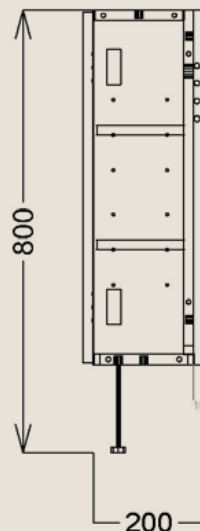
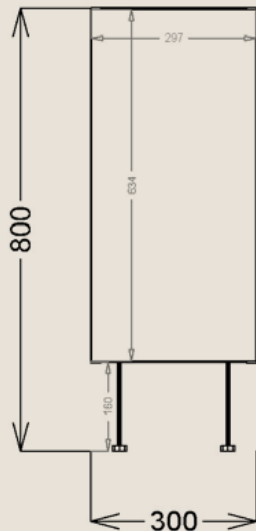
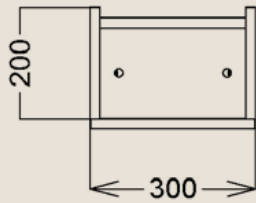

Furniture Dimension

300 1 DOOR 1
DRAWER UNIT
STANDARD DEPTH

Serene

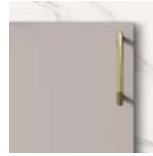

Maison



Willow

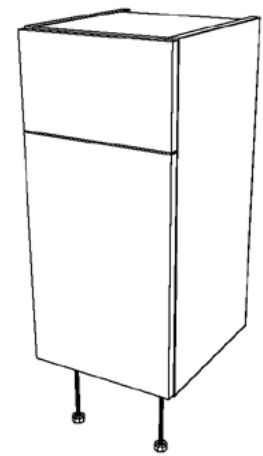
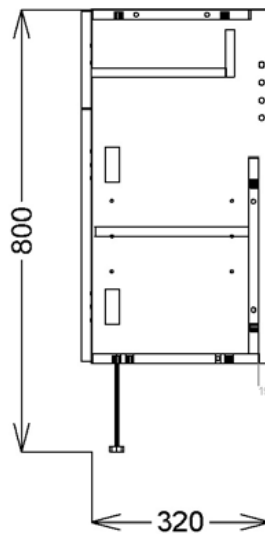
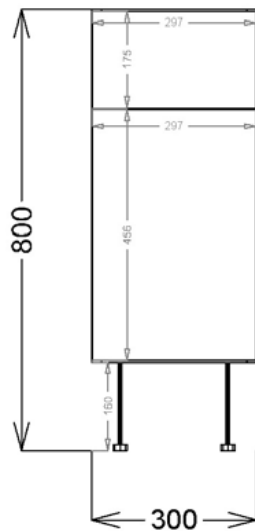
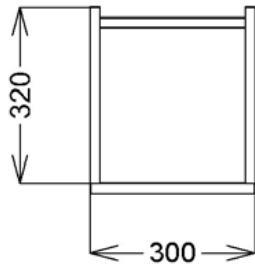

300 3 DRAWER UNIT STANDARD DEPTH

Serene

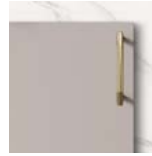

Maison



Willow

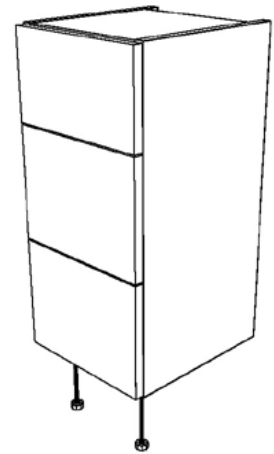
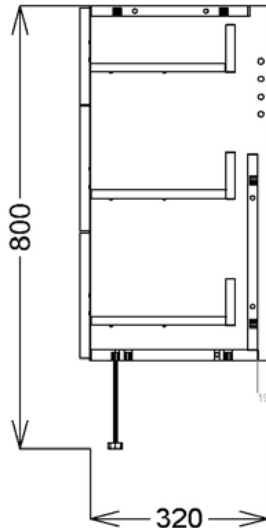
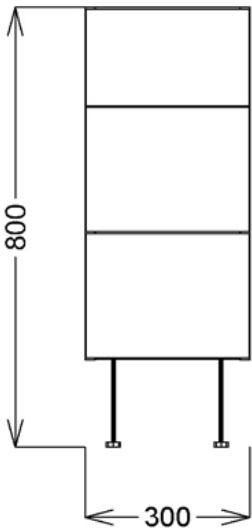
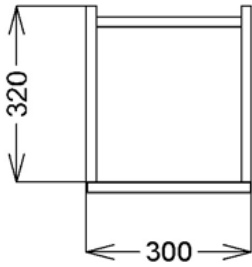

300 TALL UNIT STANDARD DEPTH TRADITIONAL

Maison

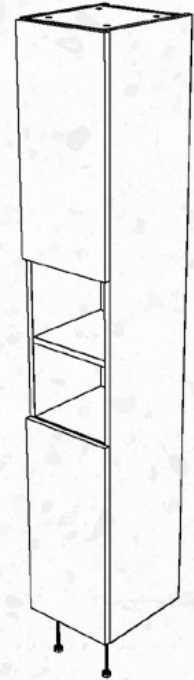
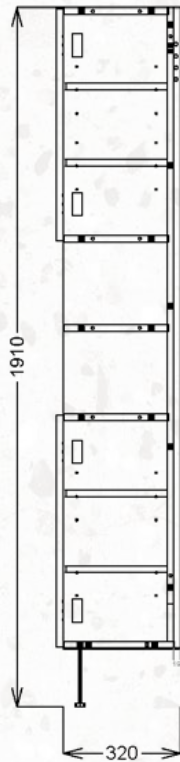
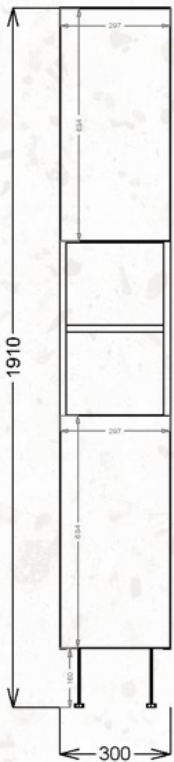
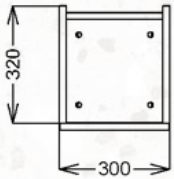

300 TALL UNIT STANDARD DEPTH MODERN

Serene



Willow

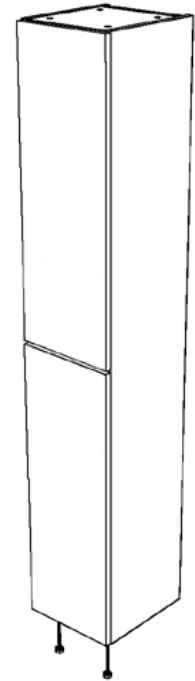
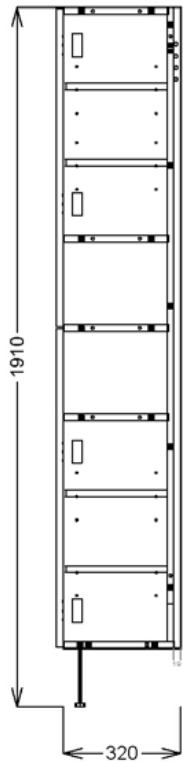
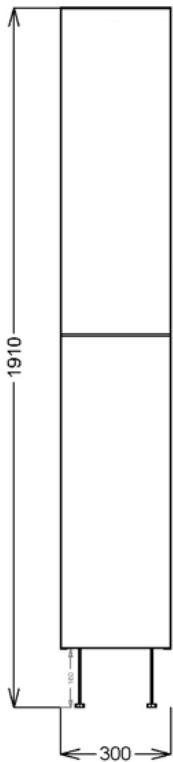
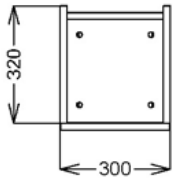

COMBINATIONS



Scan to View
Fitted Furniture Brochure





Combinations

600 BASIN CABINET
300 3 DRAWER UNIT
& 600 WC UNIT
FLOOR STANDING

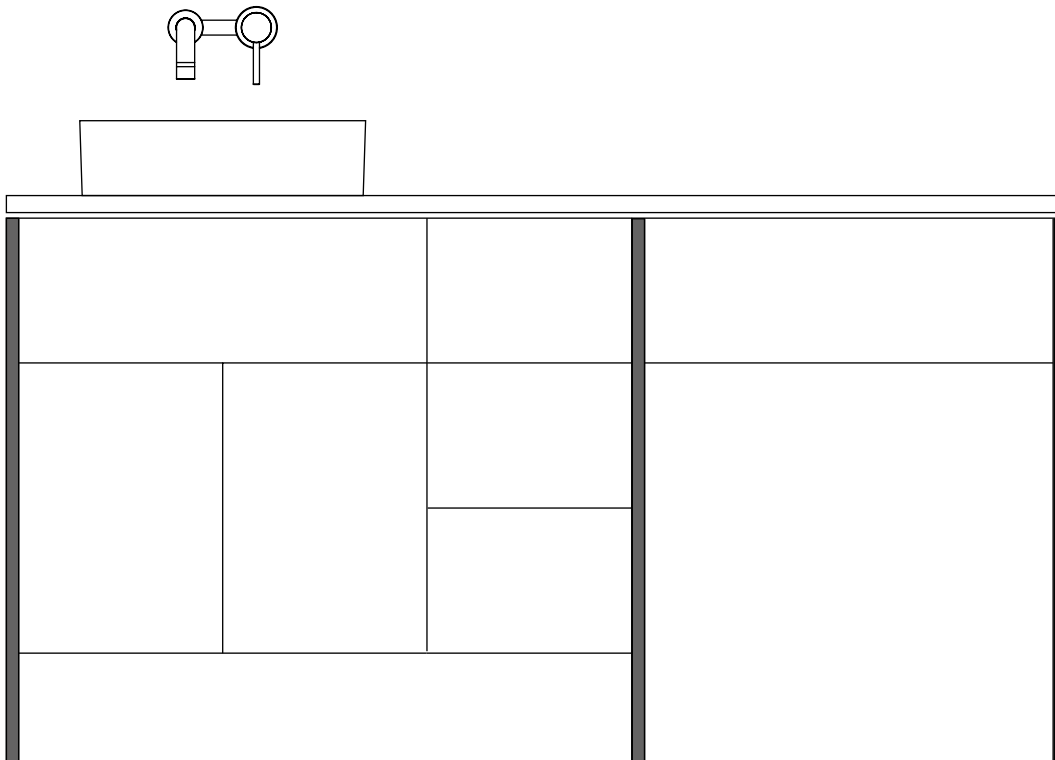

600 BASIN CABINET
& 300 3 DRAWER UNIT
WALL HUNG

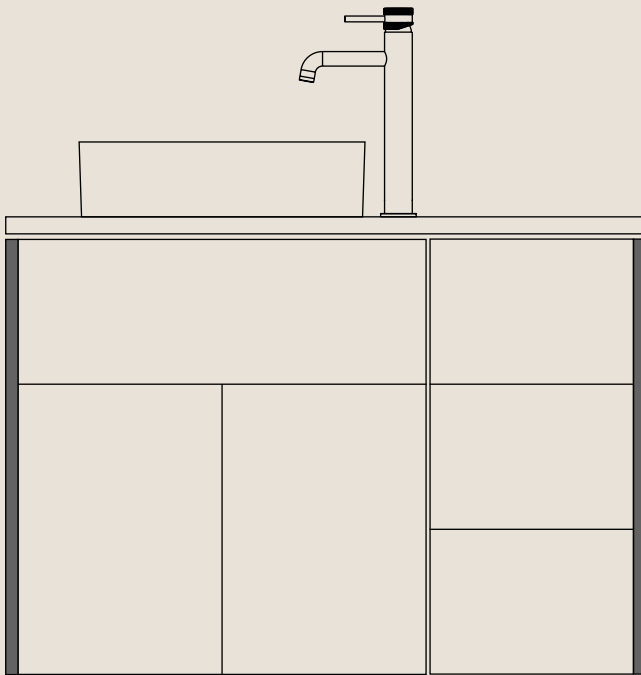

Combinations

500 BASIN CABINET
300 1 DOOR UNIT X2
FLOOR STANDING

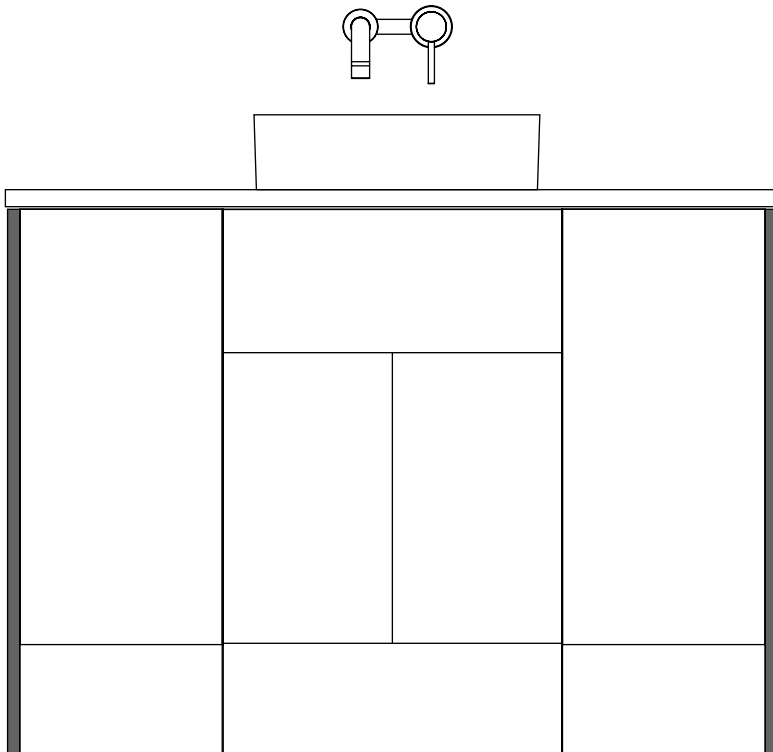

600 BASIN CABINET X2
& 300 1 DOOR UNIT
FLOOR STANDING

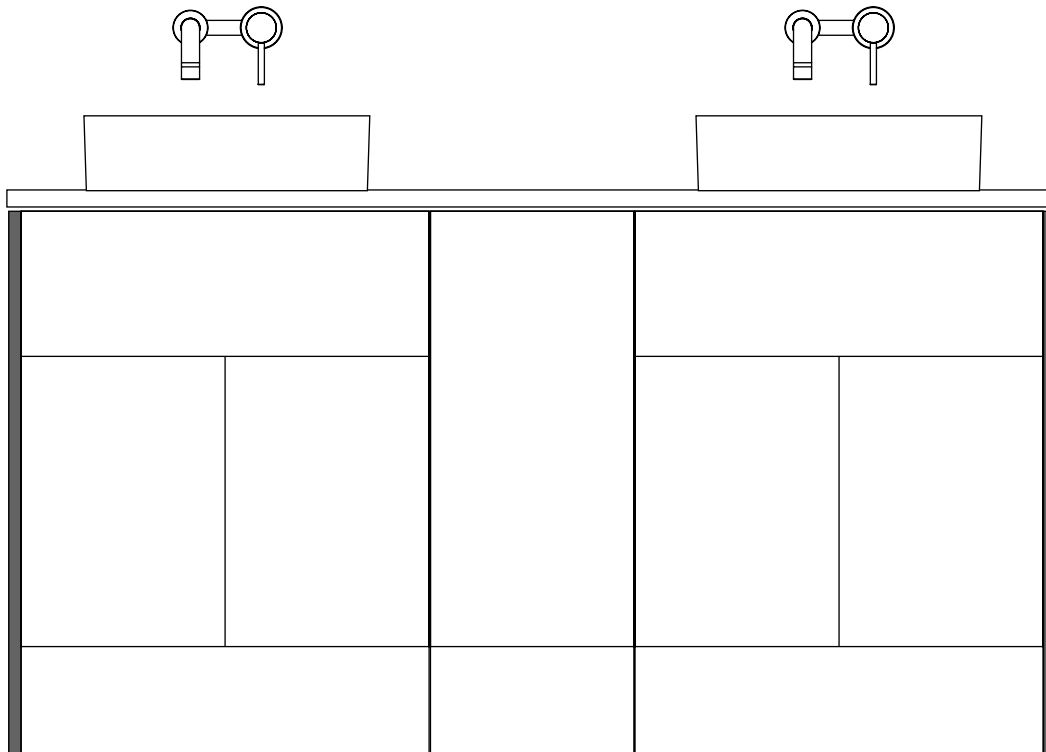

Combinations

600 BASIN CABINET
300 1 DOOR UNIT X2
500 WC UNIT
FLOOR STANDING

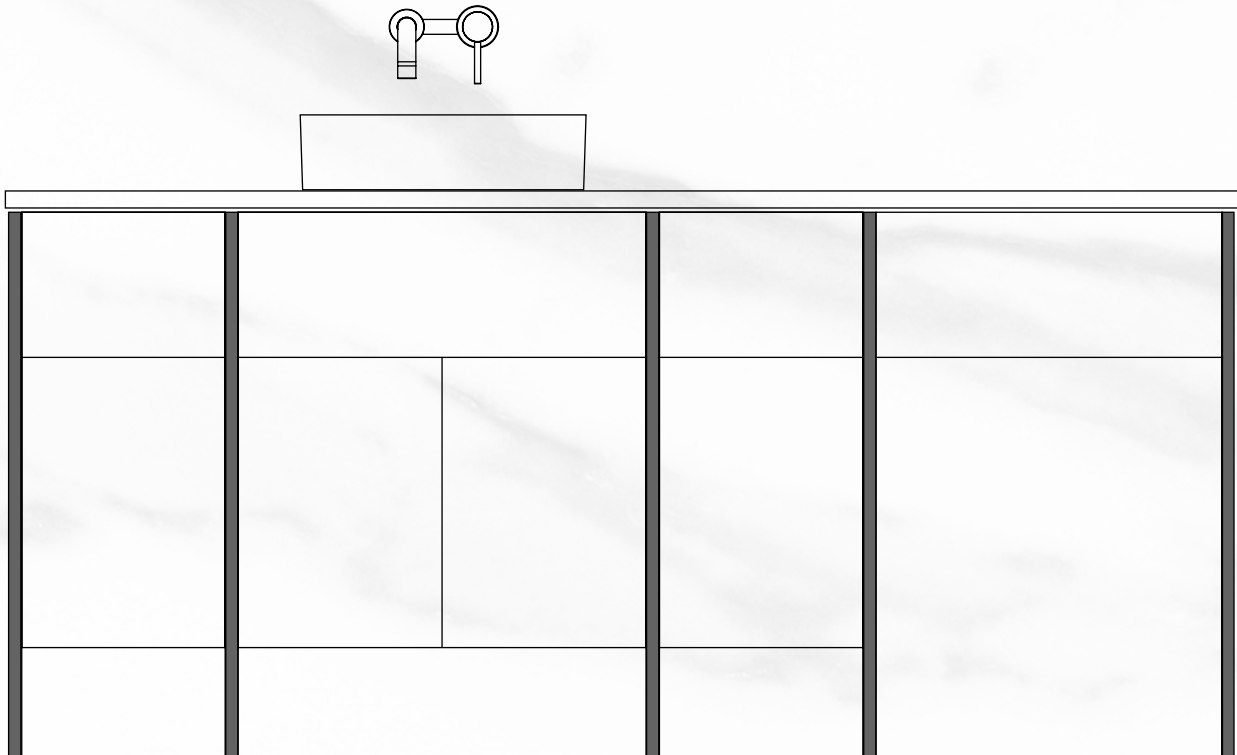

600 BASIN CABINET
300 1 DOOR UNIT X2
WALL MOUNTED

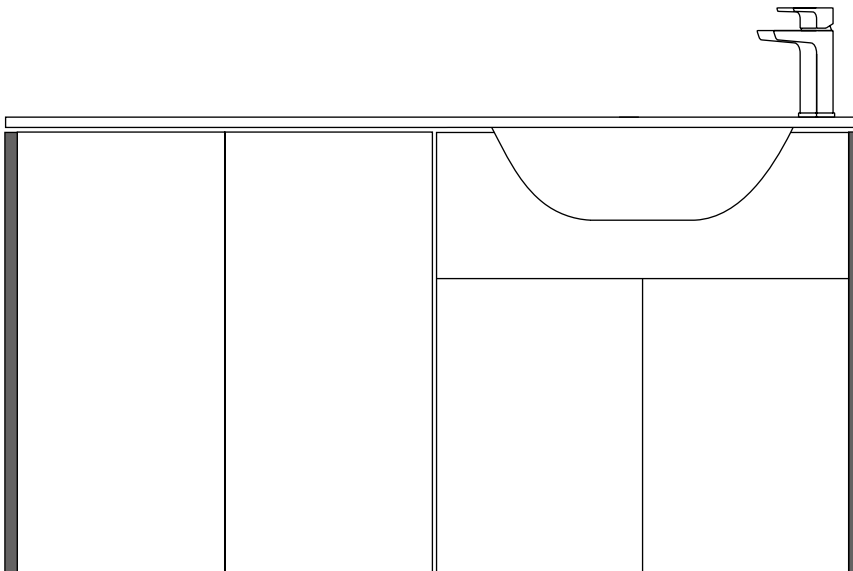

FOR INSTRUCTION
MANUALS VISIT THE
SCUDO WEBSITE



SCAN
TO VIEW





SCUDO

BEAUTIFUL BATHROOMS

0330 124 7290
sales@harrisonbathrooms.com

scudo.co.uk



HARRISON
BATHROOMS

Scudo is a brand and trading name - owned by Harrison Bathrooms Ltd.
Gelderd Cross Warehouse, 94 Gelderd Road, Leeds, West Yorkshire, LS12 6HJ.

11/25 V1